

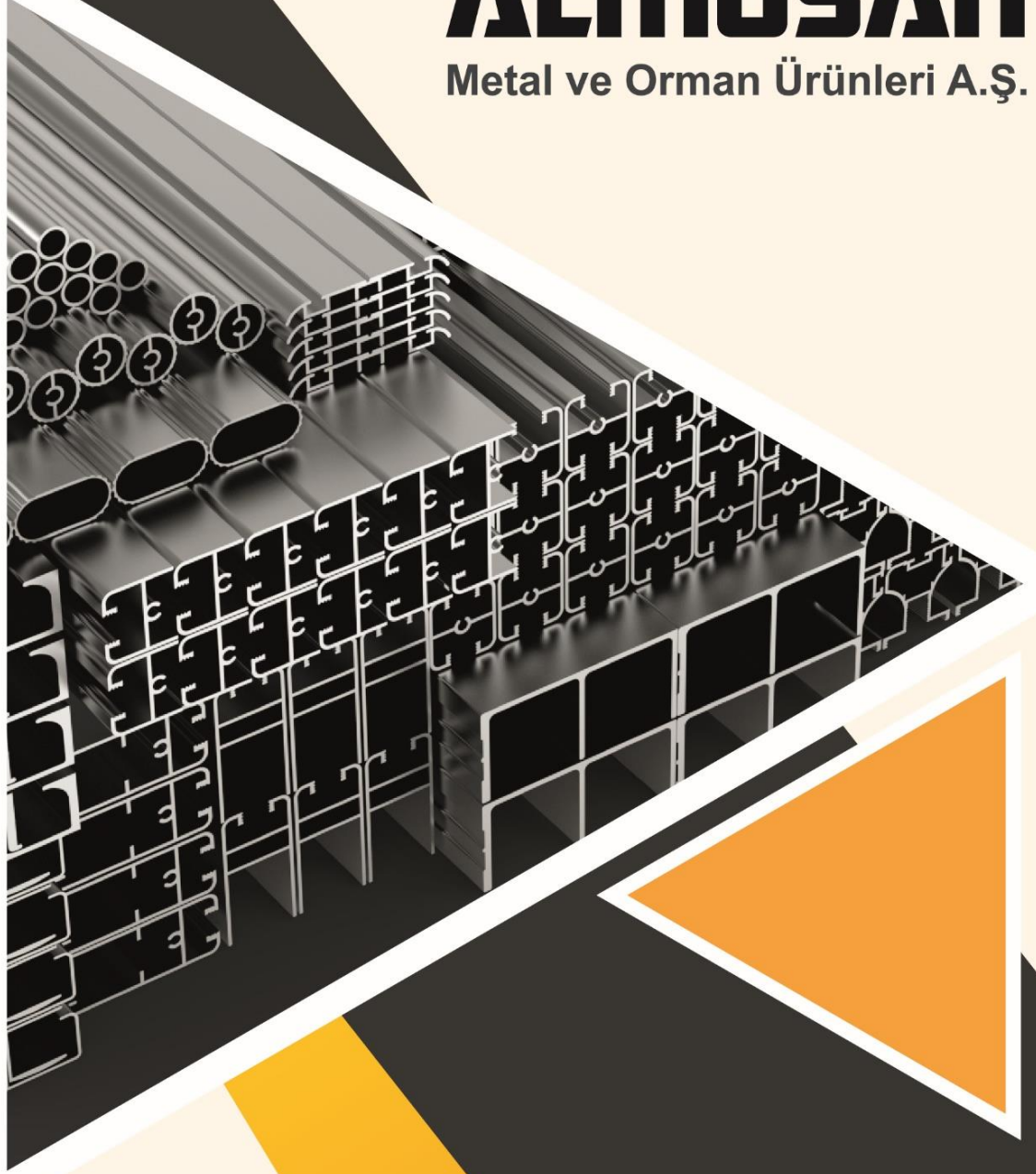

# ALMOSAN

Metal ve Orman Ürünleri A.Ş.



☎ 0 (222) 340 58 77

☎ 0552 665 26 26

📍 Baksan Sanayi Sitesi No:6/1

🌐 [www.almosan.com](http://www.almosan.com)



# İÇİNDEKİLER

**KULP PROFİLLERİ**

---

**ENTEĞRE KULP PROFİLLERİ**

---

**MUTFAK PROFİLLERİ**

---

**SUNTA KENAR BİRLEŐTİRME VE SÜS PROFİLLERİ**

---

**RAY PROFİLLERİ**

---

**HAFİF SÜRGÜ (8 MM) KAPAK PROFİLLERİ**

---

**HAFİF SÜRGÜ KAPAK AKSESUARLARI**

---

**ÇERÇEVE PROFİLLERİ**

---

4015 K / Y KULP

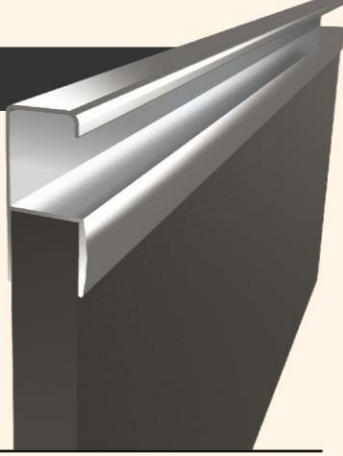
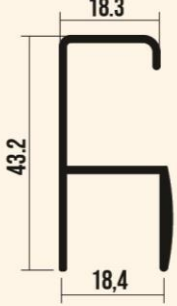

4016 K / EKO Y KULP

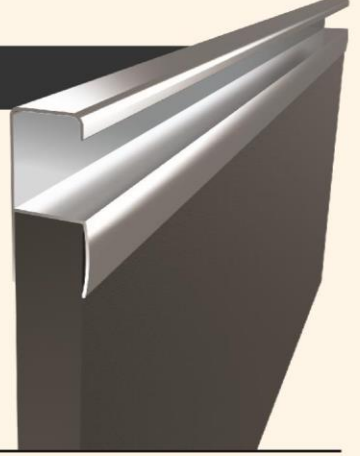

4023 K / MİNİSURF KULP

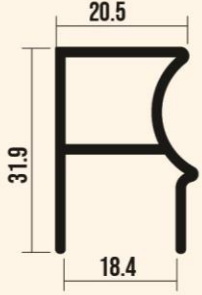

4112 K / TOPUZLU KULP

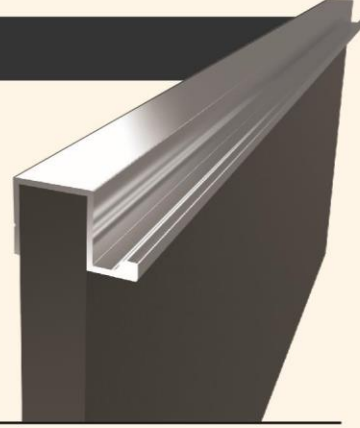
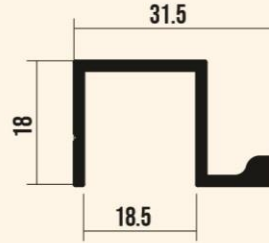

4233 K / 45'LİK KULP

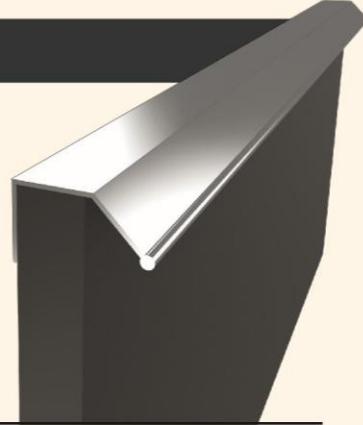
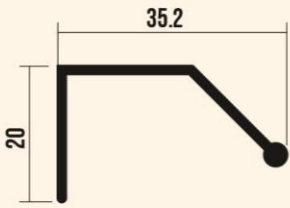

4234 K / TREND KULP

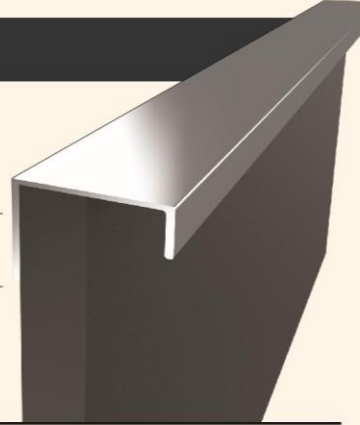
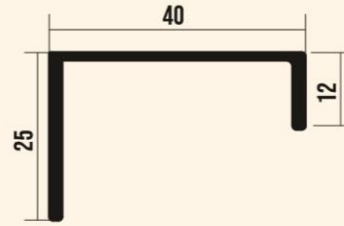

4548 K / İNKA KULP

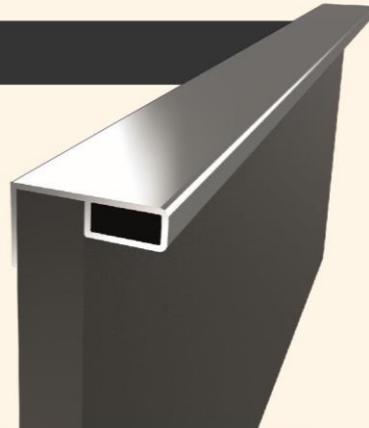
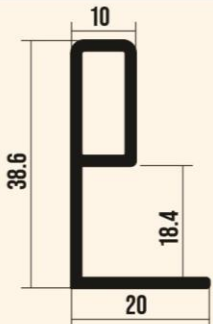

4493 K / ALBATUR 2500

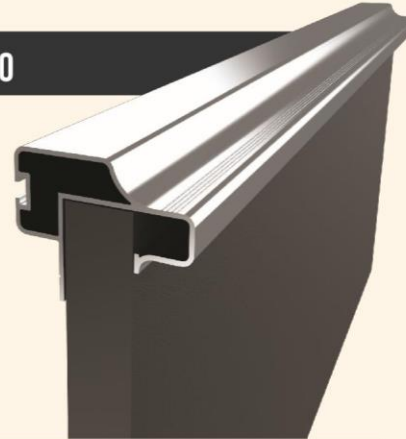
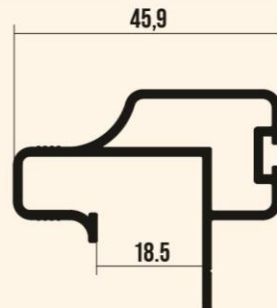

4294 EK / APAÇI KULP

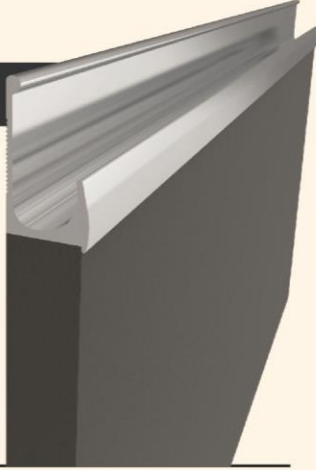
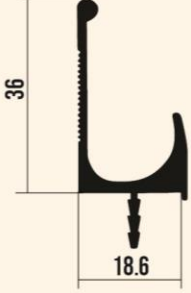

4688 EK / APAÇI EKO

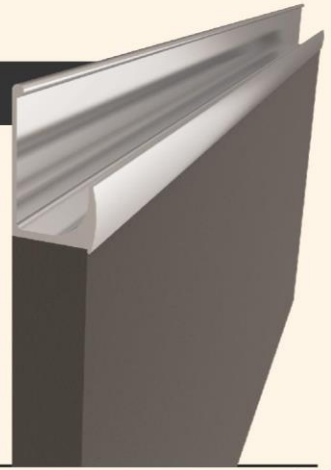
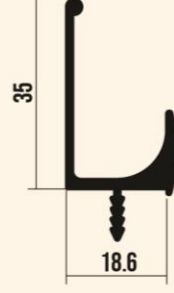

4708 EK / AY KULP

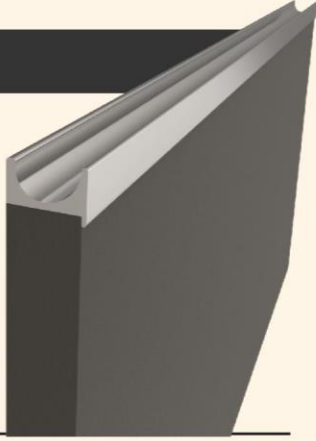
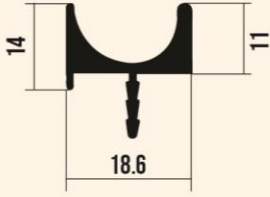

4564 EK / MAYA KULP

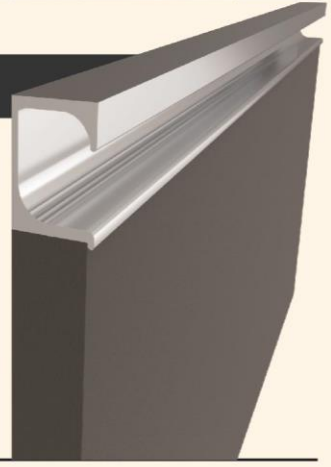
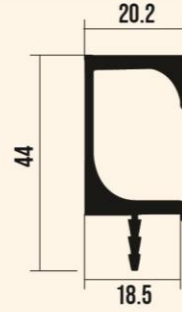

4678 EK / PARİS

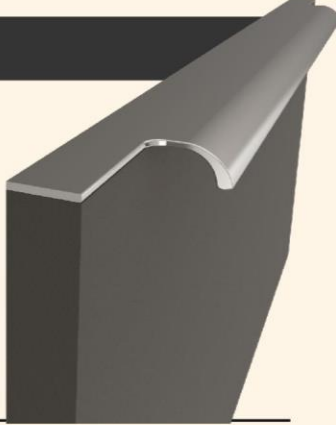

4592 EK / MİLANO

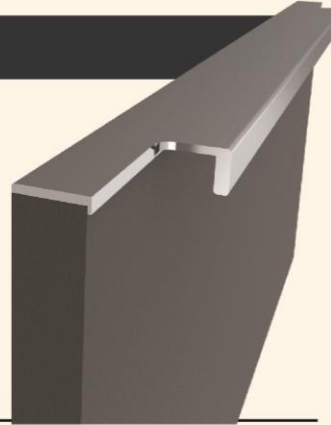
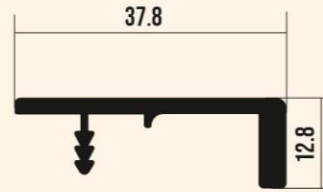

4694 EK / BERLİN

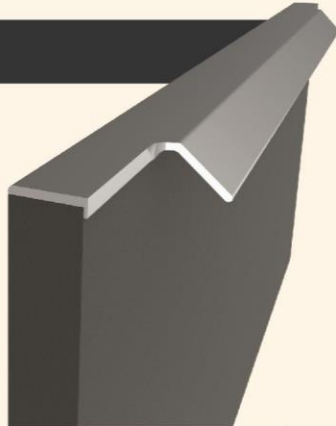
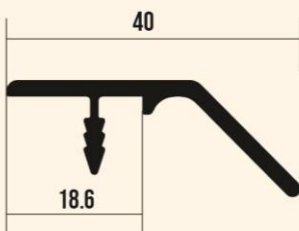

## RENK SEÇENEKLERİ



PARLAK  
ELOKSAL



MAT  
ELOKSAL



BRONZ  
ELOKSAL



KİMYASAL  
PARLAK



RAL  
RENKLERİ

RAL RENKLERİNDE ELEKTROSTATİK TOZ BOYA İMKANI

\*SİPARİŞ ESNASINDA İMALATI YAPILACAK ÖLÇÜLERİ VE PROFİL RENGİNİ BELİRTİNİZ; STOK SORUNUZ.

6250 M / EVYE KAYIT

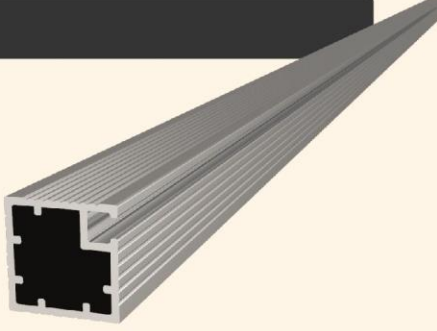
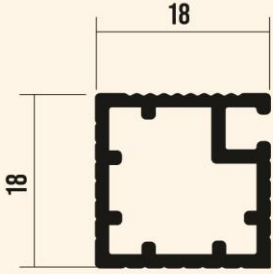

AKS 6250 / EVYE KAYIT BAĞLANTI

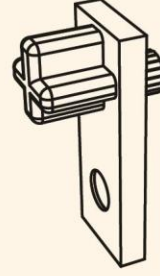

6010 M / 10'LÜK BAZA

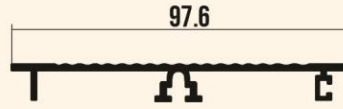

6012 M / 12'LİK BAZA

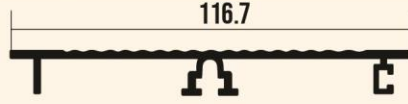

6015 M / 15'LİK BAZA

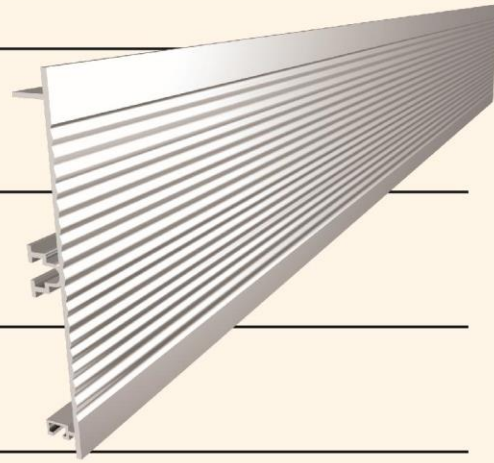
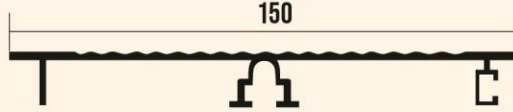

4049 MK / GİZLİ KULP TEZGAH ALTI

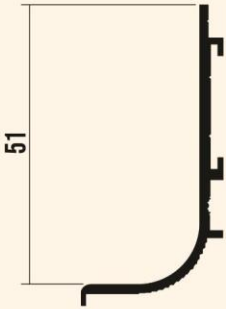

4048 MK GİZLİ KULP ÇEKMECE

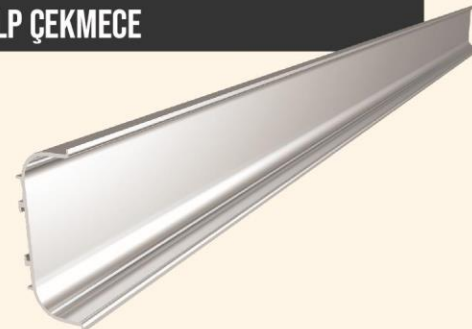

AKS 4048-49 GİZLİ KULP BAĞLANTI

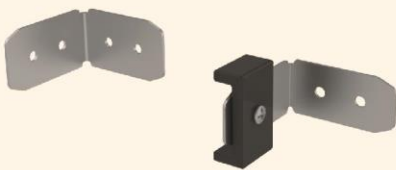

4050 MK / CUMBA KULP

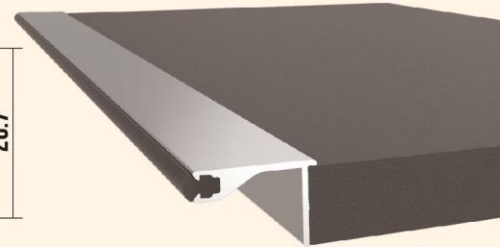
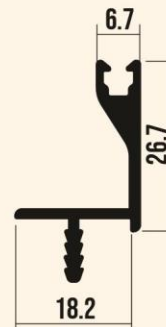

\* STOKTAKİ ÜRÜNÜN KALIBINA GÖRE  
UYGUN BAĞLANTI APARATI VERİLECEKTİR.

**5594 S / 18 MM U**

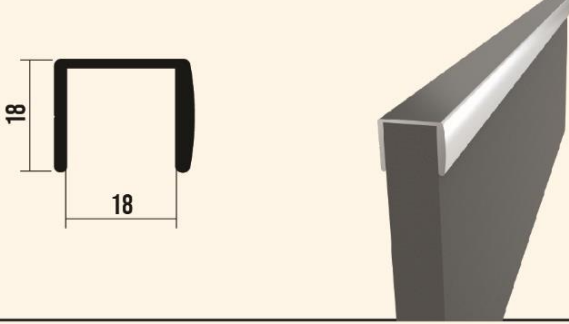

**5493 S / PARKE BİTİM**

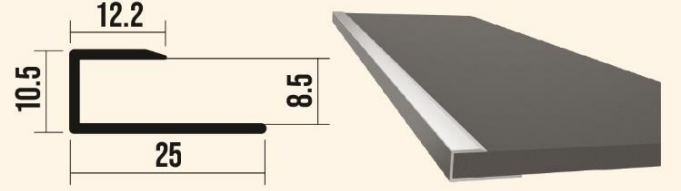

**5582 S / KENAR ÇİTA**

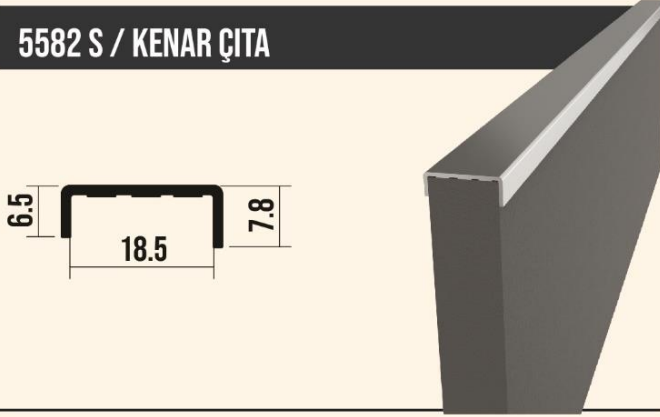

**5671 S / F ÇİTA**

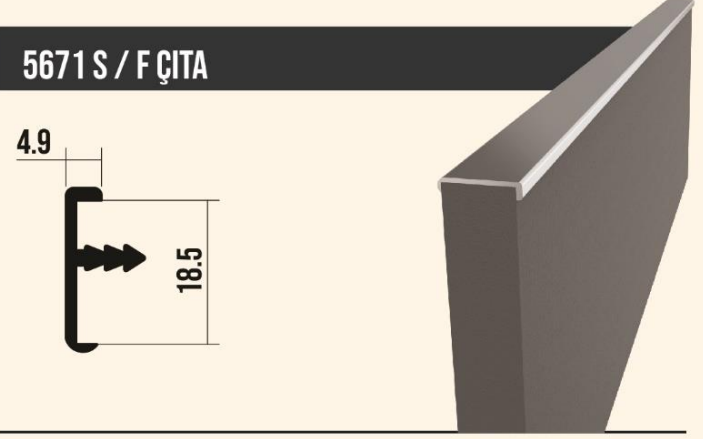

**5721 S / 36'LİK U**

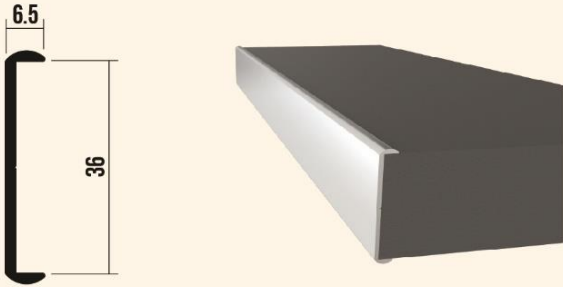

**5732 S / 42'LİK U**

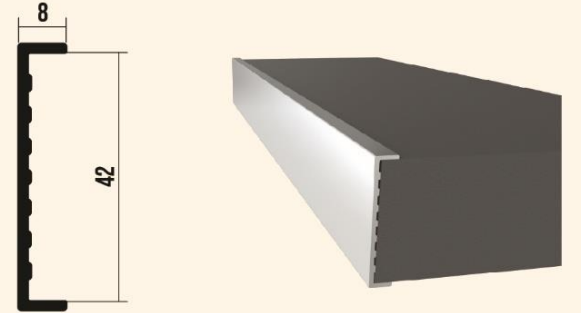

**5961 S / 18'LİK H**

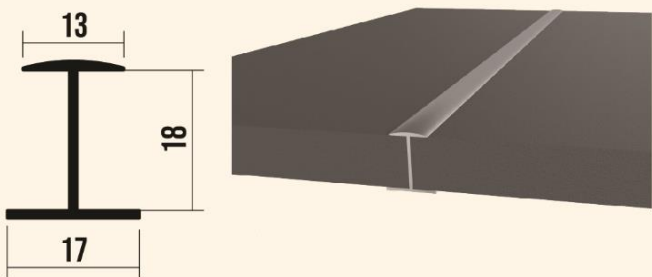

**5050 S / İNCE T PROFİL**

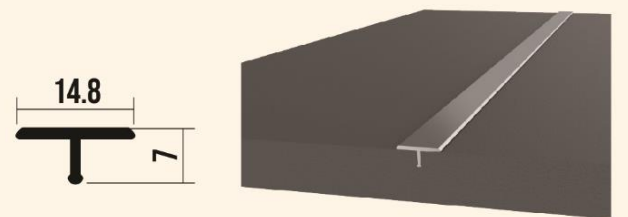

**5106 S / CAM ÇITASI**

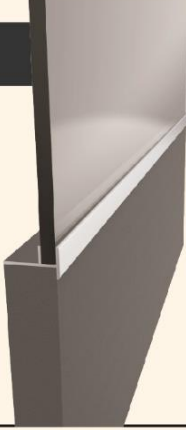
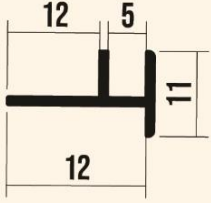

**5116 S / CAM ÇITASI**



**5712 S / KÖŞE DÖNÜŞ**

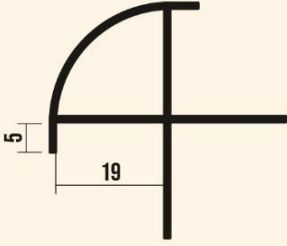

3055 R / 55'LİK ALT RAY



3730 R / SFT ALT RAY



3100 R / SRG100 ÜST RAY

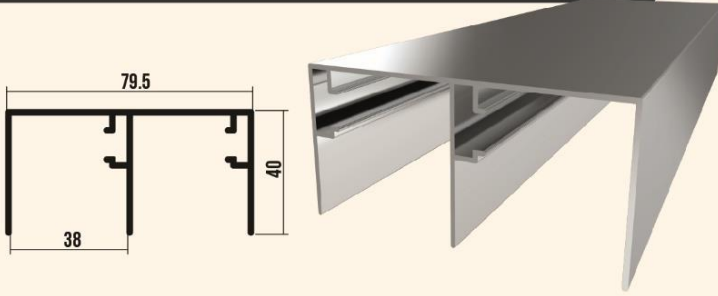

3275 R / TEKLİ ALT RAY



3040 R / TEKLİ ÜST RAY



3010 R / GÖMME RAY

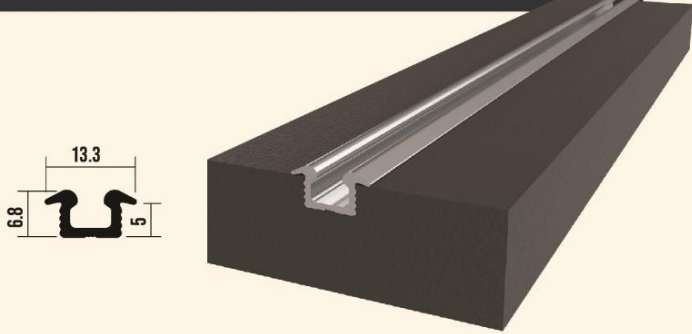

3732 R / SFT ÜST RAY

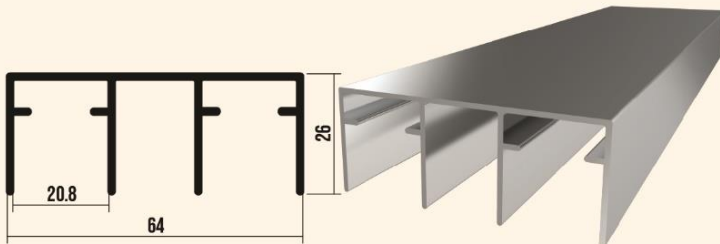

3080 R / SKM80 ÜST RAY

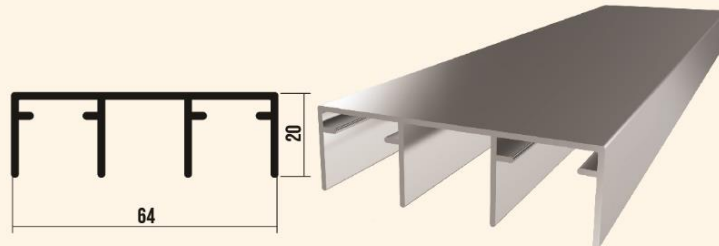



**SR 2122 / ÜST ÇİTA**

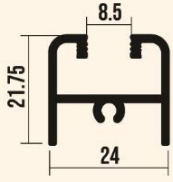

**SR 2126 / ORTA ÇİTA**

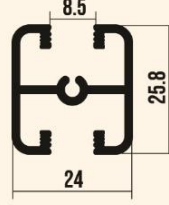

**SR 2548 / ALT KAYIT**

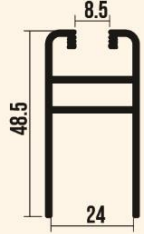

**SR 2472 / GAMA ÜST RAY**

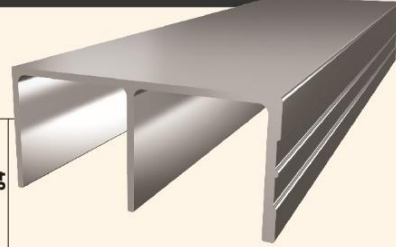
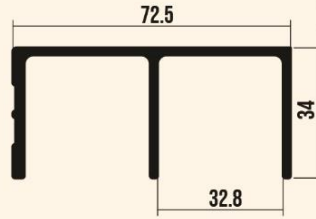

**SR 2332 / GAMA KULP**

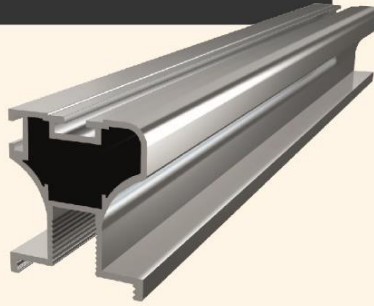
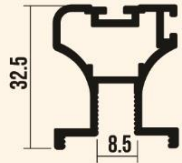

**SR 2454 / GAMA ALT RAY**

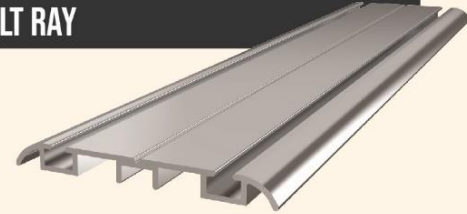
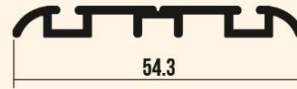

**SR 2553 / ALT KAYIT (ÇİFT TEKER)**

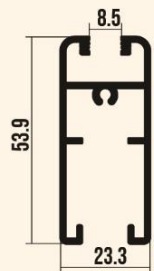

**GAMA STANDART TEKER**

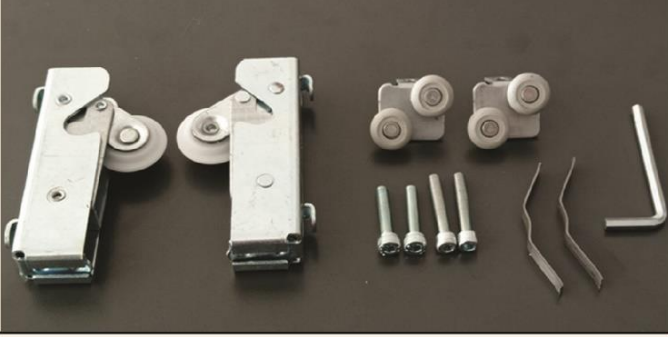

**GAMA İÇ BÜKEY TEKER**



**GAMA ÇİFT TEKER**



**ALB 6920 GAMA FREN**



**ALB 6921 GAMA FREN**

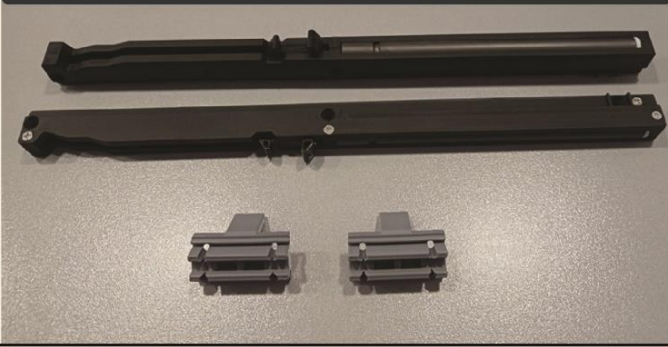

**GAMA EKO FREN**

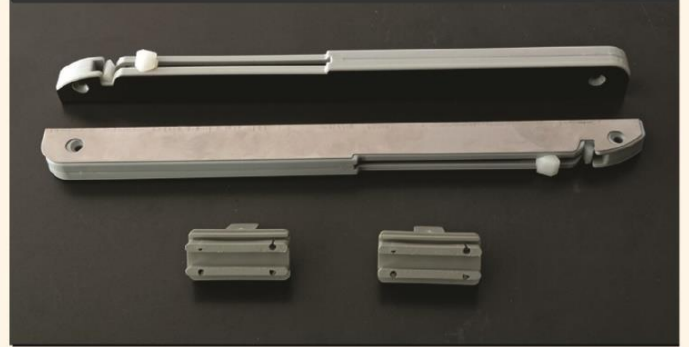

**GAMA FİTİL GRUPLARI**



**ALBATUR 7030 SFT (ÜST TEKER RULMANLI)**



**ALBATUR 7030 (ÜST TEKER RULMANSIZ)**



**ALBATUR SRG 100 (ÇİFT YÖNE FRENLİ)**



**ALBATUR 6950 (50KG - YAVAŞLATICI)**



**ALBATUR 6970 (70 KG - YAVAŞLATICI)**



**ALBATUR**<sup>®</sup>  
produces quality

**FİRMAMIZ ALBATUR ENDÜSTRİ A.Ş. BAYİSİDİR.  
TALEP ETTİĞİNİZ DİĞER ÜRÜNLERİ FİRMA YETKİLİSİNE BİLDİRİNİZ.**



**ALMOSAN**

Metal ve Orman Ürünleri A.Ş.

**7301 F / FİX ÇERÇEVE**

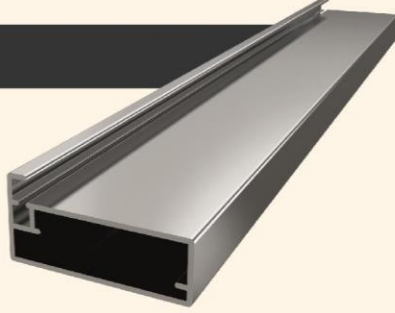
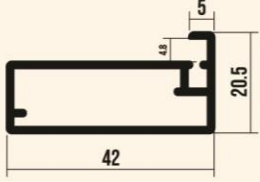

**7302 FK / FİX ÇERÇEVE KULP**

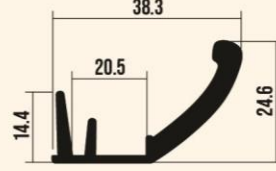

**7924 F / YAPIŞMA ÇERÇEVE**

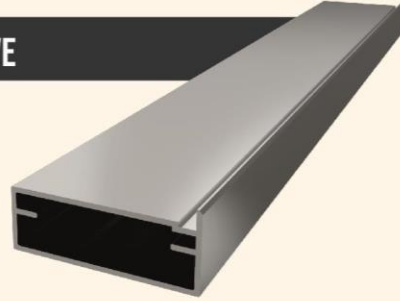
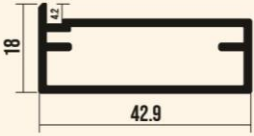

**7925 FK / YAPIŞMA ÇERÇEVE KULP**

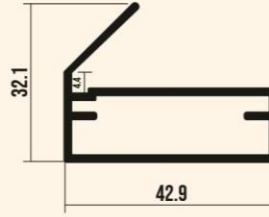

**7908 F / BOY KULP ÇERÇEVE**

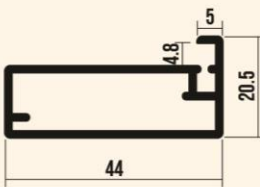

**7909 FK / BOY KULP**

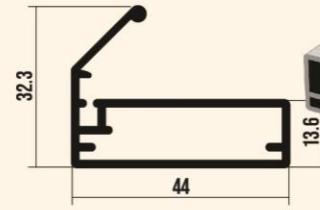

**7626 F / YAPIŞMA 2**

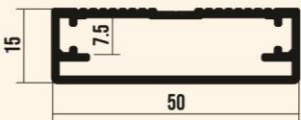

**7627 FK / YAPIŞMA 2 KULP**

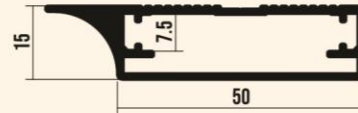

7046 F / 20X42 ÇERÇEVE

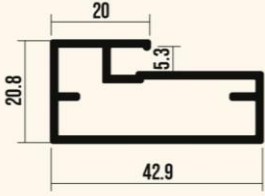

7020 F / 20X20 ÇERÇEVE

